

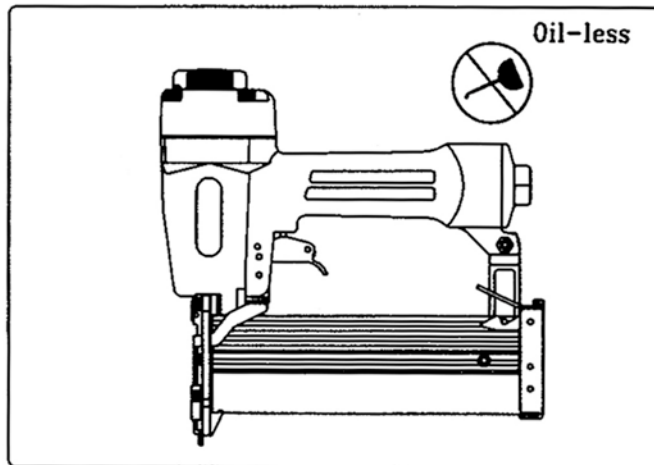

2 IN 1 STAPLER/BRAD NAILER KIT FOR MODEL G9248

18GA, 15-50mm (5/8" ~ 2") NAILS
18GA, 1/4" CROWN 8-40mm (5/16" ~ 1 9/16") STAPLES

INSTRUCTION MANUAL



• CAUTION !!
READ INSTRUCTION BEFORE LOADING NAILS OR STAPLES.

COPYRIGHT © 1999 BY GRIZZLY INDUSTRIAL, INC.
WARNING : NO PORTION OF THIS MANUAL MAY BE REPRODUCED IN ANY SHAPE
OR FORM WITHOUT THE WRITTEN APPROVAL OF GRIZZLY IMPORTS, INC.
PRINTED IN TAIWAN

TECHNICAL DATA

Model..... G9248

Dimension (Length× Width× Height).....229.6(9")x 58(2.3")x240(9.4")mm

Weight..... 1.45kgs (3.19bs)

Air inlet..... NPT 1/4"
 PT 1/4"

Compressed air:

Maximum permissible operating pressure.....110psi (7.8bar)

Recommended operating pressure..... 60 ~ 100psi (4.1 ~ 6.9 bar)

Fastener range.....
18 Ga. Staples 8 ~ 40mm (5/16" ~ 1 9/16")
18 Ga. Brad nails 15 ~ 50mm (5/8" ~ 2")

Nail/Staple capacity.....100pcs

NOISE CHARACTERISTIC VALUES IN ACCORDANCE WITH Enxx1:

A-weighted single-event sound pressure level at operator's position: $L_{pA,1s}=92\text{dBA}$

A-weighted single sound pressure level: $L_{pA,1s,1m}=87\text{dBA}$

VIBRATION CHARACTERISTIC VALUES IN ACCORDANCE WITH ISO8662;
PART II: Weighted root mean square acceleration = 1.5m/s^2

**(※ AT WORKPLACE, ALWAYS WEAR HEARING PROTECTION
EQUIPMENT※)**

NOTE

1. To Load Nails

1-1. Press the rear latch to slide out the magazine cover.

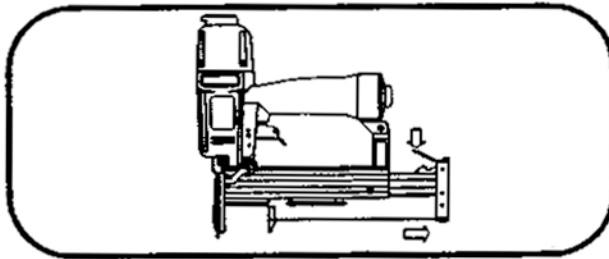

1-2. Hold the tool horizontally.

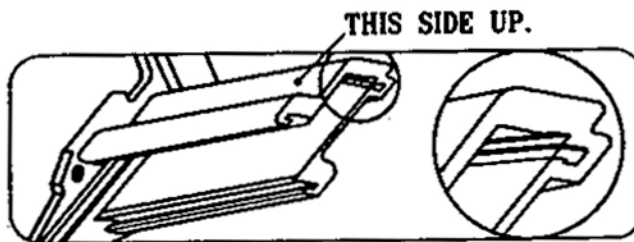

1-3. Attach brads to the nail guide (brad slot) on the inner top of the magazine. Ensure brad heads are attached to it.

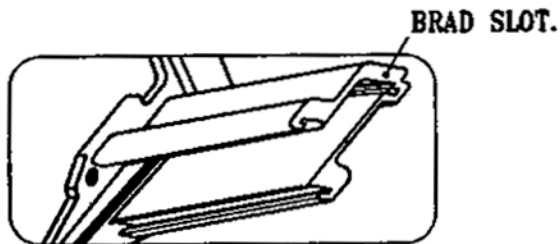

2. To Load Staples

2-1. See 1-1.

2-2. Hold the tool horizontally. Insert staples and attach them to the inner top of the magazine.

2-3.Ensure staples are attached to the inner top of the magazine. See the diagram below.

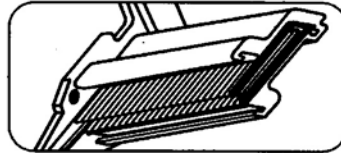

Special Features:

A. Firing Mode

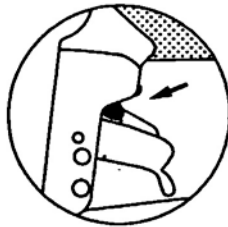

1. Single Shot/Sequential Shot
A unique design to meet both demands for fine finish nailing & high speed stapling.
2. Switch clockwise for sequential-shot mode.
3. Switch counterclockwise for single-shot mode.

B. Depth-of-drive Adjustment

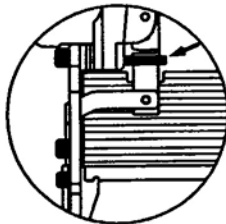

2. Innovative driver blade system & depth-of-drive adjustment ensure no countersink marking for extra fine nailing operation.

Rotate finger wheel to adjust depth of drive.

3.Kit complete with:

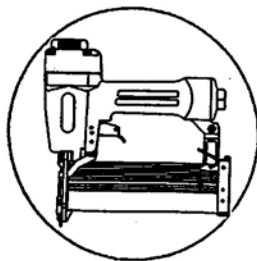

- 1.Oiler
- 2.Safety Goggle
- 3.Allen Wrenches
- 4.Compact Carrying Case
- 5.Nails Assortment :1¹/₄"x1,000pcs
2"x1,000pcs
- 6.Staples Assortment :1"x400pcs
1¹/₄"x400pcs

WARNING 

Depicts a potentially hazardous situation that, if not avoided, could result in death or serious injury.

DANGER 

Depicts an imminently hazardous situation that, if not avoided, could result in death or serious injury.

NOTE

Emphasizes useful information.

SAFETY INSTRUCTIONS

DANGER 



- Do not attempt to operate the tool until you read and understand all safety precautions and manual instructions.



- Never allow to use oxygen or combustible gas as a power source for the tool. Use filtered, lubricated, regulated compressed air only.



- Never use gasoline or other flammable liquids to clean the tool. Vapors in the tool will ignite by a spark and cause the tool to explode.



- Do not exceed **maximum permissible operating pressure 7.8bar(115psi)**.
- Any tool equipped with contact actuation with a safety yoke shall not be used



- if changing one driving location to another involves the use of stairs, ladders or scaffolding.
-for closing boxes or crates and for fitting transportation safety systems.

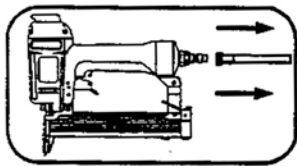

- Disconnect the tool from air supply before clearing jams, performing repairs and during non-operation

WARNING



- Do not keep the trigger pulled on safety yoke mechanism when carrying or holding the tool. Never carry the tool by the hose or pull the hose to move the tool.
Carry the tool only by the handle.



- At the workplace, always wear the protective equipment such as Z87.1 safety glasses, ear and head protection.

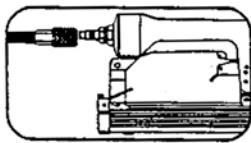

- Do not use a check valve or any other fitting that allows air to remain in the tool.



- Never point any operational fastener driving tool at yourself or at any other person.

COMPRESSED AIR SYSTEM

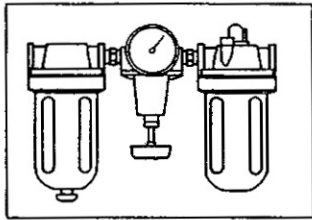

- Many air tool users find it convenient to use an oiler to help provide oil circulation through the tool and increase the efficiency and useful life of the tool. Check oil level in the oiler daily. Many air tool users find it convenient to use a filter to remove liquid and impurities which can rust or wear internal parts of the tool. A filter also increases the efficiency and usefulness of the tool. The filter must be checked on a daily basis and if necessary drained.

NOTE

- When the air pressure in the line system exceeds the maximum permissible operating pressure of the tool, a pressure reducing valve followed by a downstream safety valve must additionally be fitted in the supply line to the tool,

NOTE

- Compressed air pipelines should be laid so as to form a gradient (highest point in the direction to the compressor). Easily accessible water separators should be installed at the lowest points.

NOTE

- Junctions for operators should be joined to the pipelines from above.

CONNECTION TO THE COMPRESSED AIR SYSTEM

NOTE

The following illustration shows the correct mode of connection to the compressed air system which will increase the efficiency and useful life of the tool.

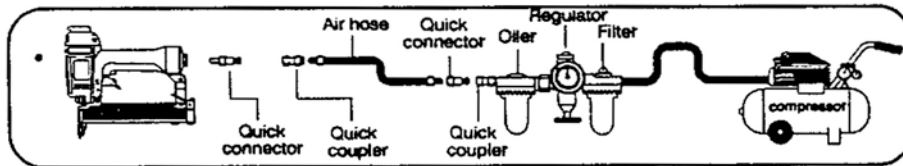

- For better performance, install a 3/8" quick connector with an inside diameter of .315" on your tool and a 3/8" quick coupler on the air hose.

SAFETY YOKE MECHANISM

● Checking operation of safety yoke mechanism

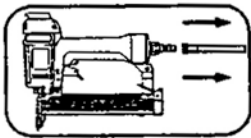

1. Disconnect the air supply from the tool.

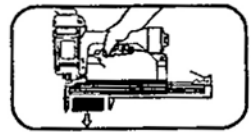

2. Empty the magazine.

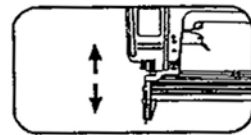

3. Make sure the trigger and safety yoke mechanism move up and down without any sticking.

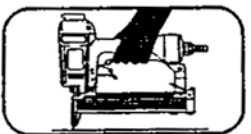

4. Connect compressed air system to the tool.

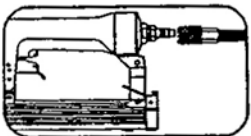

5. Depress the safety yoke mechanism against the workpiece without pulling the trigger. The tool must not cycle. Never use the tool if a cycle occurs

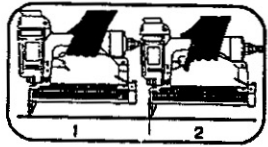
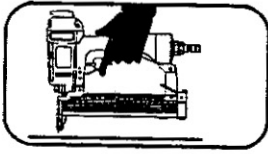

6. Hold the tool clear of the workplace. The safety yoke mechanism should return to its original down position. Pull the trigger. The tool must not cycle. Never use the tool if a cycle occurs.
7. Depress the safety yoke mechanism against the workpiece and pull the trigger the tool must cycle.

● **Operating a safety yoke mechanism:**

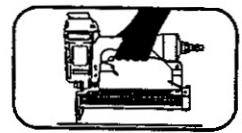
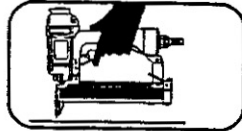
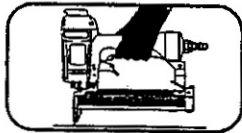

1. The operator requires finger to be off the trigger and the nose of the tool to be placed on workpiece.
2. The safety yoke mechanism is then depressed against the workpiece and the trigger is pulled to drive a fastener.
3. The trigger is released after each fastener is driven.
4. Move the tool to the next location and the above procedure repeated.

TOOL LOADING

WARNING



- Never point any operational fastener driving tool at yourself or at any other person.

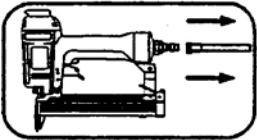

- Disconnect air hose.

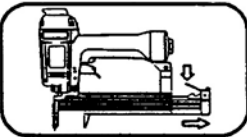

- Depress the magazine latch. Pull back on the magazine cover.

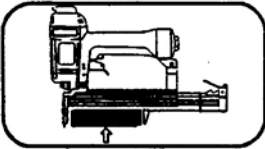

- Insert a stick of fasteners into the magazine. Make sure the pointed ends of the fasteners are resting on the bottom edge of the magazine.

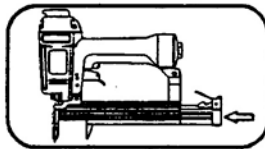

- Push the magazine cover forward until the latch catches.

TOOL OPERATION



Protect your eyes and ears. Wear Z87.1 safety glasses with side shields. Wear hearing protection. Employers and users are responsible for ensuring the user or anyone near the tool wears this safety protection.

NOTE

Check and replace any damaged or worn components on the tool. The safety warning labels on the tool must also be replaced if they are not legible.

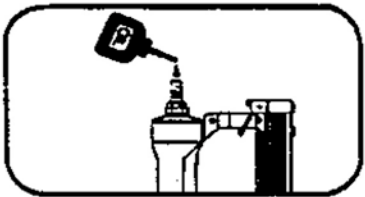

1. Add a few drops of UNOCAL RX22 or 3-in-1 oil into the air inlet.

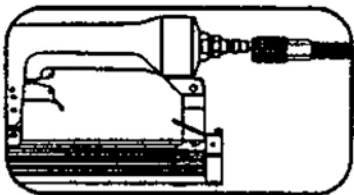

2. Install a quick connect fitting to the tool.

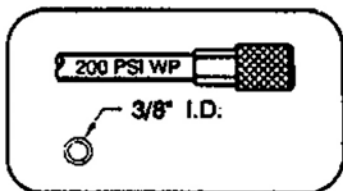

3. Connect the tool to an air compressor using a 3/8" I.D. hose. Make sure the magazine must be empty of all fasteners and the hose has a rated working pressure exceeding 200 psi (13.8 bar) and a female quick coupler.

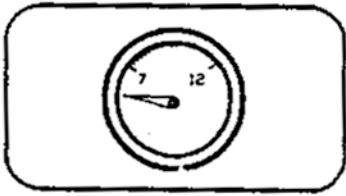

4. Regulate the air pressure to obtain 62 psi (4.1 bar) at the tool . Check the operation of the safety yoke mechanism following the instructions in this manual.

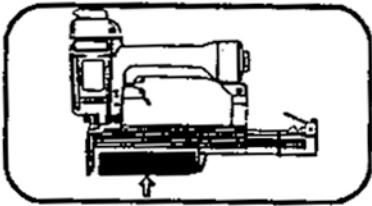

5. Insert fasteners into your tool following the instructions of loading the tool.

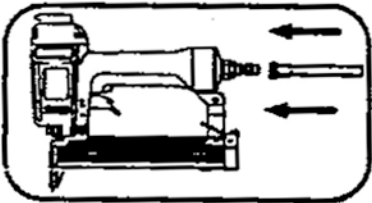

6. Reconnect the air hose to the tool.

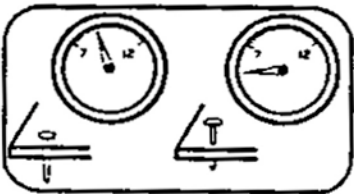

7. Test for proper fastener penetration by driving fasteners into a piece of wood. If the fasteners do not achieve the desired penetration, regulate the air pressure to a higher setting until the desired penetration is achieved. Do not exceed 7.8 bar(115psi) at the tool.

HANDLING THE TOOL

DANGER ⚠



Never use gasoline or other flammable liquids to clean the tool. Vapors in the tool will ignite by a spark and cause the tool to explode and result in death or serious personnel injury.

NOTE

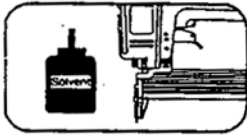

Solvents used to clean the nose of the tool and safety yoke mechanism may soften the tar on the shingles and cause the buildup to be accelerated. Make sure to dry the tool thoroughly after cleaning and before operating the tool again.

NOTE

- Avoid triggering the tool if the magazine is empty.

NOTE

- Any defective or improperly functioning tool must immediately be disconnected from the compressed air system.

NOTE

- The compressed air connectors of the tool and the hoses must be protected against contamination. The ingress of coarse dust, chips, sand, etc., will result in leaks and damage to the tool and the couplings.

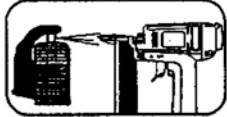
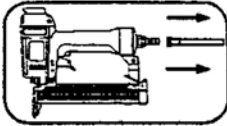

- Disconnect the air supply from the tool.
- Remove tar buildup with kerosene #2 fuel oil or diesel fuel. Do not allow solvent to get into the cylinder or damage may occur. Dry off the tool completely before use.

TOOL MAINTENANCE

WARNING



Disconnect the tool from air compressor before adjusting, clearing jams, servicing, relocating and during non operation.



- **LUBRICATION:**
 1. Your tool requires lubrication before you use it for the first time.
 2. Disconnect the compressed air system from the tool before lubricating.

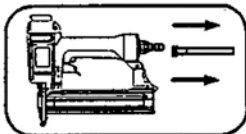

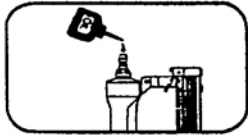

3. Turn the tool so the inlet is facing up and put one drop of spindle oil, UNOCAL RX22, or 3-in-1 oil into air inlet. Never use detergent oil or additives. Operate the tool briefly after adding oil.

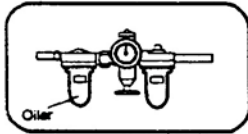

4. Wipe off excessive oil at the exhaust. Excessive oil will damage O-rings of tool. If in-line oiler is used, manual lubrication through the air inlet is not required on a daily basis.

● **CLEARING A JAM FROM THE TOOL**
Fastener jammed inside magazine:

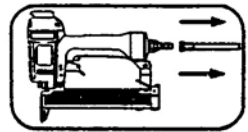

1. Disconnect tool from compressed air system.

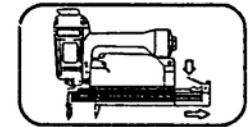

2. Press down on latch and pull back on magazine.

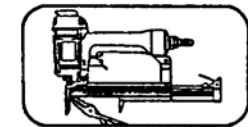

3. Remove jammed fastener and push magazine cover forward until latch catches.

TROUBLESHOOTING

WARNING

Stop using the tool immediately if any of the following problems occurs. Serious personal injury could occur. Any repairs or replacements must be done by a qualified person or an authorized service center only.

PROBLEM	CAUSE	CORRECTIVE ACTION
Air leaking at trigger valve area.	O-rings in trigger valve housing are damaged.	O-rings must be replaced & operation of safety yoke mechanism must be checked.
Air leaking between housing and nose.	Loose screws in housing.	screws need to be tightened.
	Damaged O-ring.	O-rings must be replaced.
	Damage to bumper.	Bumper needs to be replaced.
	Loose screws.	Screws need to be tightened.
Air leaking between housing and cap assy.	Damaged seal.	Seal needs to be replaced.

PROBLEM	CAUSE	CORRECTIVE ACTION
Tool skips driving fastener.	Worn bumper.	Bumper needs to be replaced.
	Dirt in nose.	Clean.
	Dirt or damage prevents fasteners from moving freely in magazine.	Magazine needs to be cleaned.
	Inadequate air flow to tool.	Fitting hose or air compressor needs to be checked.
	Worn O-ring on piston or lack of lubrication.	O-rings need to be replaced. Lubricate.
	Damaged O-rings on trigger valve.	O-rings need to be replaced.
	Air leaks. Cap seal leaking.	Screws and fittings need to be tightened. Seal needs to be replaced.

PROBLEM	CAUSE	CORRECTIVE ACTION
Tool runs slowly or has loss of power.	Tool not lubricated sufficiently.	Tools need to be lubricated.
	Broken spring in cap assy.	Spring needs to be replaced.
	Exhaust port in cap is blocked.	Damaged internal parts need to be replaced.
Fasteners are jammed in tool.	Driver guide worn or damaged.	Replace driver guide.
	Driver is damaged.	Replace driver.
	Fasteners are not correct size.	Fasteners recommended for tool must be used.
	Fasteners are bent.	Replace with undamaged fasteners.
	Magazine or nose screws are loose.	Screws need to be tightened.

FASTENERS

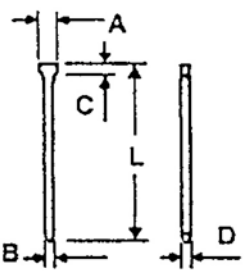
FASTENER FIGURE:	NAIL	
	L	$5/8'' \sim 2''$ (15-50mm)
	A	$0.075'' \sim 0.087''$ (1.9-2.2mm)
	B	$0.039''$ (1.0mm)
	C	$0.043''$ (1.1mm)
	D	$0.049''$ (1.25mm)

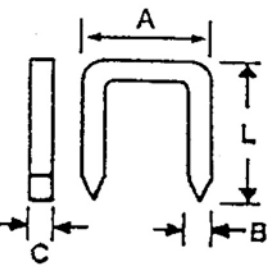
FASTENER FIGURE:	STAPLE	
	L	$5/16'' \sim 19/16''$ (8-40mm)
	A	$1.4''$ (5.8mm)
	B	$0.039''$ (1.0mm)
	C	$0.049''$ (1.25mm)

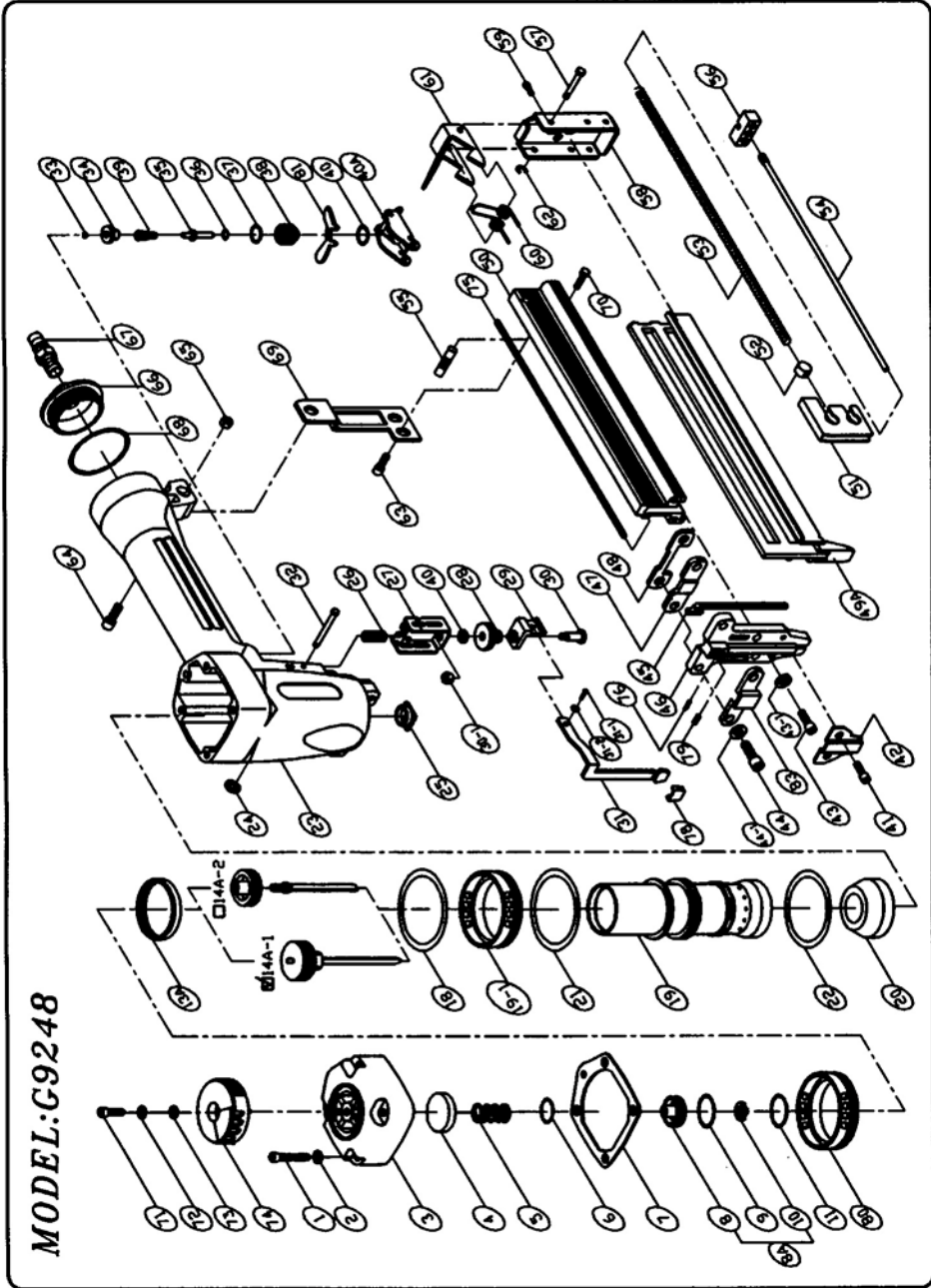

PARTS LIST (G9248)

*When ordering spare parts, please state item no, part no. and description.

ITEM	PART NO	DESCRIPTION	ITEM	PART NO	DESCRIPTION	ITEM	PART NO	DESCRIPTION
1	HS0530B	HEX.SOC.HD.BOLT	30-1	LN0400N	LOCK NUT	54	11305401	ROD
2	SW0500W	SPRING WASHER	31	17903103	SAFETY LEVER	55	11305501	SHAFT
3	13900305	CAP	31-1	HS0305B	HEX.SOC.HD.BOLT	56	11305601	SET BLOCK
4	12100401	SEAL	31-2	SW0300W	SPRING WASHER	57	11605701	STEPPED PIN
5	12100501	SPRING	32	12103202	STEPPED PIN	58	17905801	END CORE
6	OR1425R	O RING	33	OR0319R	O RING	59	US0510B	UM.HD.BOLT
7	11100701	CAP SEAL	34	11003401	TRIGGER VALVE HEAD	60	11306001	TOR. SPRING
8A	13900801A	PISTON HEAD VALVE ASM.	35	11003503	TRIGGER VALVE STEM	61	11606101	STOPPER
8	13900801	PISTON HEAD VALVE	36	OR2515H	O RING	62	ER0200H	E RING
9	OR2435R	O RING	37	OR1119R	O RING	63	HS0410B	HEX.SOC.HD.BOLT
10	12101001	STOPPER	38	11003803	TRIGGER VALVE GUIDE	64	HS0516B	HEX.SOC.HD.BOLT
11	OR3224R	O RING	39	11006901	SPRING	65	LN0500N	LOCK NUT
13	13901302A	OIL-LESS PISTON RING ASM.	40	PR0515R	PU RING	66	11106601	COVER
14A-1	17901403A	DRIVER ASSEMBLY	40A	13904501A	TRIGGER ASSEMBLY	67	12106401	AIR PLUG
14A-2	17901404A	DRIVER ASSEMBLY	41	HS0406B	HEX.SOC.HD.BOLT	68	OR4030R	O RING
18	OR4630R	O RING	42	17904201	NOSE COVER	69	17906901	BRACKET
19	13901902G	CYLINDER	43	HS0416B	HEX.SOC.HD.BOLT	70	HS0408B	HEX.SOC.HD.BOLT
19-1	13901903	COLLAR	43-1	SW0400W	SPRING WASHER	71	US0506B	UM.HD.BOLT
20	13902001	BUMPER	44	HS0522B	HEX.SOC.HD.BOLT	72	FW0512W	FLAT.WASHER
21	OR3520R	O RING	44-1	SW0500W	SPRING WASHER	73	12103301	SEAL
22	OR3635R	O RING	45	17904501	NAIL GUIDE PLATE	74	13907403	EXHAUST COVER
23	13902301	BODY	46	17904601	NOSE	75	17907501	LINER
24	OR1919H	O RING	47	11304701	SET PLATE	76	RP2510S	ROLLED PIN
25	12102501	JOINT GUIDE	48	10904801	SET PLATE	78	13403101	RUBBER PAD
26	11002601	SPRING	49A	17904901A	STAPLE GUIDE UNIT	79	17907901	SPRING
27	11002702	GUIDE SAFETY LEVER	50	17905001	MAGAZINE	80	13907001	COLLAR
28	18103201	SAFETY ADJUSTING NUT	51	12505101	PUSHER	81	13907701	SINGLE/BUMP FIRE SWITCH
29	13403001	GUIDE PLATE	52	11205201	SLIDE BLOCK	83	17908301	SET PLATE
30	18104601	SET SHAFT	53	11305301	SPRING			